



Top quality roller cabinet exclusively for Tool Rebels.

- Exclusive roller cabinet in the Tool Rebel design
- Extremely robust thanks to a double-walled design
- With 7 drawers (5 flat, 2 high) – of which 2 flat drawers are equipped with foam inserts and tools
- Dimensions flat drawers (width x height x depth): 522 x 81 x 398 mm
- Dimensions high drawers (width x height x depth): 522 x 166 x 398 mm
- 100 % drawer pull-out with ball bearing telescopic slides, self-closing
- All drawers are elaborately and individually layered
- Minimum risk of tilting over thanks to the drawer stop – only one drawer can be opened, no simultaneous pull-out of multiple drawers
- High-quality, durable foam inserts without chemical vapours
- Optimum fit for the best possible removal of the tools from the foam inserts



9700 Tool Rebel roller cabinet 1



Includes the following foam inserts:

9710



9720

1/4"

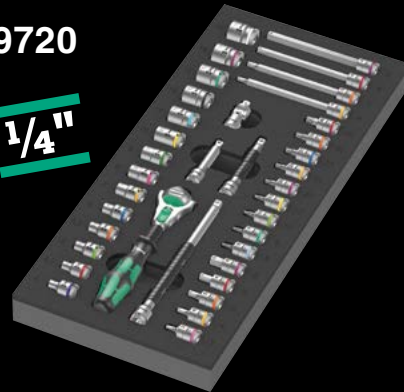

9731



9740



Exclusive roller cabinet in the Tool Rebel design. Five flat and two high drawers ensure efficient, mobile organization of tools and materials. Extremely robust design thanks to a double-walled design and the completely welded construction of the entire body. For daily hard work in the workshop. Equipped with four Wera foam inserts: 9710 foam insert screwdriver set 1, 9720 foam insert 8000 A Zyklop ratchet set 1, 9731 foam insert 6003 Joker ring spanner set 1, 9740 foam insert L-key set 1.

05150130001 1x 9700 Tool Rebel roller cabinet 1

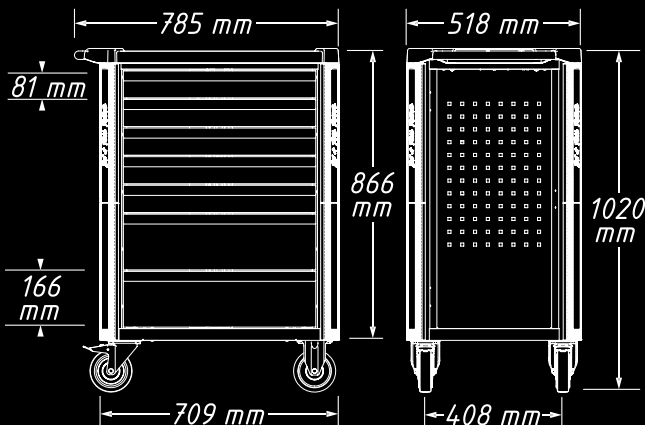

Robust design for hard work in the workshop



The double-walled design and the completely welded construction make the Tool Rebel roller cabinet extremely robust. The optimized yielding edge protection on all four corners ensures reliable impact protection thanks to an internal cushioning action.

Secure locking, smooth running



The two swivel castors are equipped with a double stop: The locked castor reliably prevents it from rolling away, the locked spindle carrier prevents the castors from turning unintentionally, e.g. on sloped surfaces. The oil- and acid-resistant elastic wheels ensure smooth running. A protective ring prevents the ingress of dirt and threads.

Detailed locking concept for more security



The ergonomically arranged lateral position of the lock improves usability and protects the key and lock from damage. The extremely robust locking system protects the tools stored in the roller cabinet against unauthorized access. The central locking is completed by a cylinder lock. Two folding keys are included.

High loads



The dynamic load of the roller cabinet is 540 kg, the static load is 1,000 kg and the drawer load is 25 kg.

9710 Foam insert screwdriver set 1



18-piece tool set (16 screwdrivers, 2 screw grippers) in a two-coloured foam insert for the Tool Rebel roller cabinet. Width x height x depth: without tools 344 x 30 x 392 mm, with tools 344 x 47 x 392 mm.

05150101001		
⊖	932 A	1x 1,0x5,5x100; 1x 1,2x7,0x125
⊕	350	1x PH 1x80; 1x PH 2x100; 1x PH 3x150
⊕	350 PH Stubby	1x PH 2x25
⊕	355	1x PZ 1x80; 1x PZ 2x100
⊖	335	1x 0,8x4,0x100; 1x 1,0x5,5x125
⊖	334	1x 1,2x6,5x150
⊖	335 Stubby	1x 1,0x5,5x24,5
⊕	2050 Micro	1x PH 0x40 ¹⁾
⊖	2035 Micro	1x 0,40x2,5x80
⊖	160 i VDE	1x 0,4x2,5x80 ²⁾ ; 1x 0,6x3,5x100 ²⁾
	1441	1x 4,5-6,0x41,0
	1442	1x 6,0-8,5x41,0
	9810	1x 344,0x30,0x392,0

¹⁾ Size 0 modified according to JCIS 0 (Japanese Camera Industrial Standard)

²⁾ without Lasertip

9711 Foam insert VDE screwdriver set 1

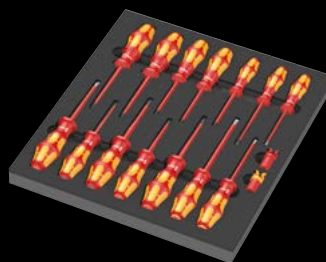

16-piece VDE-insulated screwdriver set (14 screwdrivers, 2 screw grippers) in a two-coloured foam insert for the Tool Rebel roller cabinet. Width x height x depth: without tools 344 x 30 x 392 mm, with tools 344 x 46 x 392 mm.

05150102001		
⊕	162 iS PH VDE	1x PH 1x80; 1x PH 2x100
⊕	165 iS PZ VDE	1x PZ 1x80; 1x PZ 2x100
⊕	165 i PZ/S VDE	1x # 2x100
⊖	160 i VDE	1x 0,4x2,5x80 ¹⁾ ; 1x 0,8x4,0x100; 1x 1,0x5,5x125
⊖	160 iS VDE	1x 0,6x3,5x100
⊖	167 i TORX® VDE	1x TX 10x80; 1x TX 15x80; 1x TX 20x80; 1x TX 25x100; 1x TX 30x100
	1440	1x 4,5-6,0x41,0
	1442	1x 6,0-8,5x41,0
	9811	1x 344,0x30,0x392,0

¹⁾ without Lasertip

- High-quality, durable foam insert without chemical vapours
- Optimum fit for the best possible removal of the tools from the foam insert
- Water- and oil-repellent, low maintenance and easy to clean
- Protection of the tool from dirt and impact

9712 Foam insert TORX® HF screwdriver set 1

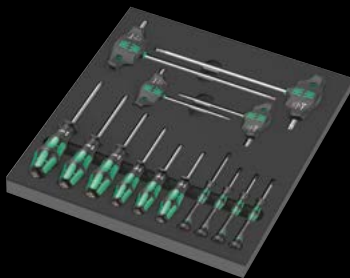

14-piece screwdriver set with holding function for TORX® screws in a two-coloured foam insert for the Tool Rebel roller cabinet. Width x height x depth (without tools): 344 x 30 x 392 mm, with tools 344 x 45 x 392 mm.

05150103001	
⊙	367 TORX® HF 1x TX 8x60; 1x TX 9x60; 1x TX 10x80; 1x TX 15x80; 1x TX 20x100; 1x TX 25x100
⊙	2067 TORX® HF Micro 1x TX 4x40; 1x TX 5x40; 1x TX 6x40; 1x TX 7x60
⊙	467 TORX® HF 1x TX 20x100; 1x TX 25x100; 1x TX 30x200; 1x TX 40x200
9812	1x 344,0x30,0x392,0

9713 Foam insert Hex screwdriver set 1

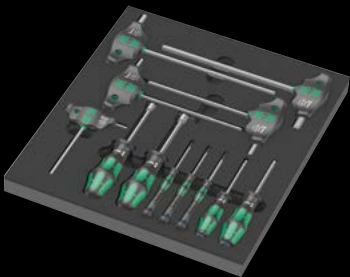

12-piece screwdriver set for hexagonal socket screws and external hexagon screws in a two-coloured foam insert for the Tool Rebel roller cabinet. Width x height x depth (without tools): 344 x 30 x 392 mm, with tools 344 x 45 x 392 mm.

05150104001	
⊙	354 1x 3,0x75; 1x 4,0x75
⊙	2054 Micro 1x 1,5x60; 1x 2x60; 1x 2,5x60
⊙	454 HF 1x 4x100; 1x 5x100; 1x 6x150; 1x 8x200; 1x 10x200
⊙	395 H0 1x 10,0x90; 1x 13,0x90
9813	1x 344,0x30,0x392,0

9720 Foam insert 8000 A Zyklop 1/4" ratchet set 1

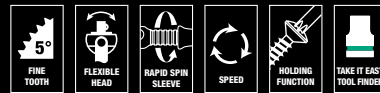

37-piece Zyklop ratchet set, 1/4", in a two-coloured foam insert for the Tool Rebel roller cabinet. Width x height x depth: without tools 172 x 30 x 392 mm, with tools 172 x 40 x 392 mm.

05150110001	
⊙	8000 A 1x 1/4"x152,0
⊙	8794 LA 1x 1/4"x150,0
⊙	8794 SA 1x 1/4"x75,0
⊙	8795 A 1x 1/4"x35,5
⊙	8794 A 1x 1/4"x56,0
⊙	8790 HMA 1x 4,0x23,0; 1x 4,5x23,0; 1x 5,0x23,0; 1x 5,5x23,0; 1x 6,0x23,0; 1x 7,0x23,0; 1x 8,0x23,0; 1x 9,0x23,0; 1x 10,0x23,0; 1x 11,0x23,0; 1x 12,0x23,0; 1x 13,0x23,0; 1x 14,0x23,0; 1x 15,0x23,0
⊙	8767 A HF 1x TX 8x28,0; 1x TX 9x28,0; 1x TX 10x28,0; 1x TX 15x28,0; 1x TX 20x28,0; 1x TX 25x28,0; 1x TX 27x28,0; 1x TX 30x28,0; 1x TX 40x28,0
⊙	8740 A HF 1x 3,0x28,0; 1x 4,0x28,0; 1x 4,0x100,0; 1x 5,0x28,0; 1x 5,0x100,0; 1x 6,0x28,0; 1x 6,0x100,0; 1x 8,0x28,0; 1x 8,0x100,0
9820	1x 172,0x30,0x392,0

9721 Foam insert 8000 B Zyklop 3/8" ratchet set 1



23-piece Zyklop ratchet set, 3/8", in a two-coloured foam insert for the Tool Rebel roller cabinet. Width x height x depth: without tools 172 x 30 x 392 mm, with tools 172 x 45 x 392 mm.

05150111001	
⊙	8000 B 1x 3/8"x199,0
⊙	8794 SB 1x 3/8"x125,0
⊙	8794 LB 1x 3/8"x200,0
⊙	8795 B 1x 3/8"x50,0
⊙	8794 B 1x 3/8"x76,0
⊙	8790 HMB 1x 6,0x29,0; 1x 7,0x29,0; 1x 8,0x29,0; 1x 9,0x29,0; 1x 10,0x29,0; 1x 11,0x29,0; 1x 12,0x29,0; 1x 13,0x29,0; 1x 14,0x29,0; 1x 15,0x29,0; 1x 16,0x30,0; 1x 17,0x30,0; 1x 18,0x30,0; 1x 19,0x30,0; 1x 20,0x30,0; 1x 21,0x30,0; 1x 22,0x30,0; 1x 24,0x32,0
9821	1x 172,0x30,0x392,0

Attention: The foam inserts do not fit in the previous model 05501051001 of the roller cabinet.

9722 Foam insert 8000 C Zyklop 1/2" ratchet set 1



31-piece set Zyklop ratchet set, 1/2", in a two-coloured foam insert for the Tool Rebel roller cabinet. Width x height x depth: without tools 344 x 30 x 392 mm, with tools 344 x 51 x 392 mm.

05150112001		
○	8000 C	1x 1/2"x277,0
●○	8794 LC	1x 1/2"x250,0
●○	8794 SC	1x 1/2"x125,0
●○	8795 C	1x 1/2"x69,0
●○	8794 C	1x 1/2"x52,0
●	8790 HMC	1x 10,0x37,0; 1x 11,0x37,0; 1x 12,0x37,0; 1x 13,0x37,0; 1x 14,0x37,0; 1x 15,0x37,0; 1x 16,0x37,0; 1x 17,0x37,0; 1x 18,0x37,0; 1x 19,0x37,0; 1x 20,0x37,0; 1x 21,0x37,0; 1x 22,0x37,0; 1x 24,0x37,0; 1x 27,0x40,0; 1x 30,0x42,0; 1x 32,0x42,0
○	8740 C HF	1x 4,0x60,0; 1x 4,0x140,0; 1x 5,0x60,0; 1x 5,0x140,0; 1x 6,0x60,0; 1x 6,0x140,0; 1x 7,0x60,0; 1x 8,0x60,0; 1x 10,0x60,0
	9822	1x 344,0x30,0x392,0

9723 Foam insert Zyklop B 3/8" bit socket set 1



22-piece Zyklop bit socket set, 3/8", in a two-coloured foam insert for the Tool Rebel roller cabinet. Width x height x depth: without tools 172 x 30 x 392 mm, with tools 172 x 39 x 392 mm.

05150113001		
●●	8784 B1	1x 1/4"x3/8"x44,0
⊕	8767 B HF	1x TX 15x35,0; 1x TX 20x35,0; 1x TX 25x35,0; 1x TX 25x107,0; 1x TX 27x35,0; 1x TX 27x107,0; 1x TX 30x35,0; 1x TX 30x107,0; 1x TX 40x35,0; 1x TX 40x107,0
○	8740 B HF	1x 4,0x35,0; 1x 4,0x107,0; 1x 5,0x35,0; 1x 5,0x107,0; 1x 6,0x35,0; 1x 6,0x107,0; 1x 7,0x38,5; 1x 8,0x38,5; 1x 8,0x100,0; 1x 10,0x38,5; 1x 10,0x100,0
	9823	1x 172,0x30,0x392,0

Safe storage and quick overview

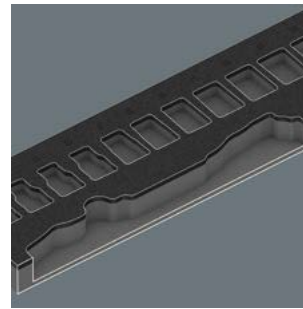

The tools sit securely in the foam thanks to precise contour cutouts, but are easy to remove. The carefully designed arrangement of the tools ensures space-saving storage and quick access to each tool.

9730 Foam insert 6000 Joker set 1



11-piece 6000 Joker ring ratchet spanner set, in a two-coloured foam insert for the Tool Rebel roller cabinet. Width x height x depth: without tools 172 x 30 x 392 mm, with tools 172 x 47 x 392 mm.

05150120001		
	6000 Joker	1x 8x144; 1x 10x159; 1x 11x165; 1x 12x170,7; 1x 13x177; 1x 14x188; 1x 15x200; 1x 16x212; 1x 17x224; 1x 18x235; 1x 19x246
	9830	1x 172,0x30,0x392,0

9731 Foam insert 6003 Joker set 1



18-piece 6003 Joker ring spanner set, 1 Kraffform bottle opener, in a two-coloured foam insert for the Tool Rebel workshop trolley. Width x height x depth: without tools 344 x 30 x 392 mm, with tools 344 x 58 x 392 mm.

05150121001		
	6003 Joker	1x 6x105; 1x 7x110; 1x 8x115; 1x 9x120; 1x 10x125; 1x 11x135; 1x 12x148; 1x 13x160; 1x 14x167; 1x 15x174; 1x 16x182; 1x 17x190; 1x 18x210; 1x 19x230; 1x 20x230; 1x 21x260; 1x 22x260; 1x 24x280
	Bottle opener	1x 145
	9831	1x 344,0x30,0x392,0

9732 Foam insert 6004 Joker set 1



5-piece 6004 Joker self-setting spanner set, in a two-coloured foam insert for the Tool Rebel workshop trolley. Width x height x depth: without tools 172 x 30 x 392 mm, with tools 172 x 35 x 392 mm.

05150122001	
	6004 Joker XS 1x 7-10 (1/4"-3/8")x117
	6004 Joker S 1x 10-13 (7/16"-1/2")x154
	6004 Joker M 1x 13-16 (1/2"-5/8")x188
	6004 Joker L 1x 16-19 (5/8"-3/4")x224
	6004 Joker XL 1x 19-24 (3/4"-15/16")x256
	9832 1x 172,0x30,0x392,0

9740 Foam insert L-key set 1

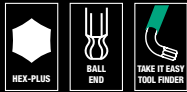

18-piece L-key set (hexagonal socket screws and TORX® screws) plus one Wera magnet and one Stabila pocket tape measure (3 m), in a two-coloured foam insert for the Tool Rebel roller cabinet. Width x height x depth: without tools 172 x 30 x 392 mm, with tools 172 x 44 x 392 mm.

05150140001					
	1x 950/9 Hex-Plus Multicolour 1				
	<table border="1"> <tr> <td>○ 950 SPKL Multicolour</td> <td>1x 1.5x90; 1x 2.0x101; 1x 2.5x112; 1x 3.0x123; 1x 4.0x137; 1x 5.0x154; 1x 6.0x172; 1x 8.0x195; 1x 10.0x224</td> </tr> </table>	○ 950 SPKL Multicolour	1x 1.5x90; 1x 2.0x101; 1x 2.5x112; 1x 3.0x123; 1x 4.0x137; 1x 5.0x154; 1x 6.0x172; 1x 8.0x195; 1x 10.0x224		
○ 950 SPKL Multicolour	1x 1.5x90; 1x 2.0x101; 1x 2.5x112; 1x 3.0x123; 1x 4.0x137; 1x 5.0x154; 1x 6.0x172; 1x 8.0x195; 1x 10.0x224				
	1x 967/9 TX XL Multicolour 1				
	<table border="1"> <tr> <td>⊕ 967 SXL TORX® Multicolour</td> <td>1x TX 8x90; 1x TX 9x101; 1x TX 10x112</td> </tr> <tr> <td>⊕ 967 SPKXL TORX® Multicolour</td> <td>1x TX 15x123; 1x TX 20x137; 1x TX 25x154; 1x TX 27x172; 1x TX 30x195; 1x TX 40x224</td> </tr> </table>	⊕ 967 SXL TORX® Multicolour	1x TX 8x90; 1x TX 9x101; 1x TX 10x112	⊕ 967 SPKXL TORX® Multicolour	1x TX 15x123; 1x TX 20x137; 1x TX 25x154; 1x TX 27x172; 1x TX 30x195; 1x TX 40x224
⊕ 967 SXL TORX® Multicolour	1x TX 8x90; 1x TX 9x101; 1x TX 10x112				
⊕ 967 SPKXL TORX® Multicolour	1x TX 15x123; 1x TX 20x137; 1x TX 25x154; 1x TX 27x172; 1x TX 30x195; 1x TX 40x224				
	1x 9500				
	1x 48.0				
	1x STABILA® BM 100 Pocket tape, metric scale, 3 m, item 19570				
	1x 3000,0				
	1x 9840				
	1x 172,0x30,0x392,0				

Two-coloured foam insert



After removing the tool the light grey second foam becomes visible and therefore missing tools are quickly identified.

9750 Foam insert Kraftform Kompakt and Tool-Check PLUS set 1



57-piece tool set (1 Tool-Check PLUS (39 pieces), 1 Kraftform Kompakt 60 (16 pieces) and one bitholding screwdriver with flexible shaft), in a two-coloured foam insert for the Tool Rebel workshop trolley. Width x height x depth: without tools 172 x 30 x 392 mm, with tools 172 x 59 x 392 mm.

05150150001																							
	1x Tool-Check PLUS																						
	<table border="1"> <tr> <td>○ 8001 A</td> <td>1x 1/4"x87.0</td> </tr> <tr> <td>● 813</td> <td>1x 1/4"x78</td> </tr> <tr> <td>⊕ 889/4/1 K</td> <td>1x 1/4"x50</td> </tr> <tr> <td>○ 870/1</td> <td>1x 1/4"x25 1)</td> </tr> <tr> <td>● 8790 HMA</td> <td>1x 5.5x23.0; 1x 6.0x23.0; 1x 7.0x23.0; 1x 8.0x23.0; 1x 10.0x23.0; 1x 12.0x23.0; 1x 13.0x23.0</td> </tr> <tr> <td>⊕ 851/1 TZ</td> <td>2x PH 1x25; 3x PH 2x25; 1x PH 3x25</td> </tr> <tr> <td>⊕ 855/1 TH</td> <td>1x PZ 1x25; 3x PZ 2x25; 1x PZ 3x25</td> </tr> <tr> <td>⊕ 867/1 TZ TORX®</td> <td>1x TX 10x25; 1x TX 15x25; 1x TX 20x25; 1x TX 25x25; 1x TX 30x25; 1x TX 40x25</td> </tr> <tr> <td>⊕ 867/1 Z TORX® B0</td> <td>1x TX 10x25; 1x TX 15x25; 1x TX 20x25; 1x TX 25x25; 1x TX 30x25</td> </tr> <tr> <td>○ 840/1 Z</td> <td>1x 3.0x25; 1x 4.0x25; 1x 5.0x25; 1x 6.0x25; 1x 8.0x25</td> </tr> <tr> <td>● 800/1 TZ</td> <td>1x 1.0x5.5x25</td> </tr> </table>	○ 8001 A	1x 1/4"x87.0	● 813	1x 1/4"x78	⊕ 889/4/1 K	1x 1/4"x50	○ 870/1	1x 1/4"x25 1)	● 8790 HMA	1x 5.5x23.0; 1x 6.0x23.0; 1x 7.0x23.0; 1x 8.0x23.0; 1x 10.0x23.0; 1x 12.0x23.0; 1x 13.0x23.0	⊕ 851/1 TZ	2x PH 1x25; 3x PH 2x25; 1x PH 3x25	⊕ 855/1 TH	1x PZ 1x25; 3x PZ 2x25; 1x PZ 3x25	⊕ 867/1 TZ TORX®	1x TX 10x25; 1x TX 15x25; 1x TX 20x25; 1x TX 25x25; 1x TX 30x25; 1x TX 40x25	⊕ 867/1 Z TORX® B0	1x TX 10x25; 1x TX 15x25; 1x TX 20x25; 1x TX 25x25; 1x TX 30x25	○ 840/1 Z	1x 3.0x25; 1x 4.0x25; 1x 5.0x25; 1x 6.0x25; 1x 8.0x25	● 800/1 TZ	1x 1.0x5.5x25
○ 8001 A	1x 1/4"x87.0																						
● 813	1x 1/4"x78																						
⊕ 889/4/1 K	1x 1/4"x50																						
○ 870/1	1x 1/4"x25 1)																						
● 8790 HMA	1x 5.5x23.0; 1x 6.0x23.0; 1x 7.0x23.0; 1x 8.0x23.0; 1x 10.0x23.0; 1x 12.0x23.0; 1x 13.0x23.0																						
⊕ 851/1 TZ	2x PH 1x25; 3x PH 2x25; 1x PH 3x25																						
⊕ 855/1 TH	1x PZ 1x25; 3x PZ 2x25; 1x PZ 3x25																						
⊕ 867/1 TZ TORX®	1x TX 10x25; 1x TX 15x25; 1x TX 20x25; 1x TX 25x25; 1x TX 30x25; 1x TX 40x25																						
⊕ 867/1 Z TORX® B0	1x TX 10x25; 1x TX 15x25; 1x TX 20x25; 1x TX 25x25; 1x TX 30x25																						
○ 840/1 Z	1x 3.0x25; 1x 4.0x25; 1x 5.0x25; 1x 6.0x25; 1x 8.0x25																						
● 800/1 TZ	1x 1.0x5.5x25																						
	1x Kraftform Kompakt 60																						
	<table border="1"> <tr> <td>● 816 R</td> <td>1x 1/4"x119</td> </tr> <tr> <td>⊕ 851/4 Z</td> <td>1x PH 1x89; 1x PH 2x89; 1x PH 3x89</td> </tr> <tr> <td>⊕ 855/4 Z</td> <td>1x PZ 1x89; 1x PZ 2x89; 1x PZ 3x89</td> </tr> <tr> <td>⊕ 867/4 Z TORX® B0</td> <td>1x TX 10x89; 1x TX 15x89; 1x TX 20x89; 1x TX 25x89; 1x TX 30x89</td> </tr> <tr> <td>● 800/4 Z</td> <td>1x 1.0x5.5x89</td> </tr> <tr> <td>○ 840/4 Z</td> <td>1x 3.0x89; 1x 4.0x89; 1x 5.0x89; 1x 6.0x89</td> </tr> <tr> <td></td> <td>Hook and Loop Fastener Strip 70</td> </tr> <tr> <td></td> <td>1x 50.0x70.0</td> </tr> </table>	● 816 R	1x 1/4"x119	⊕ 851/4 Z	1x PH 1x89; 1x PH 2x89; 1x PH 3x89	⊕ 855/4 Z	1x PZ 1x89; 1x PZ 2x89; 1x PZ 3x89	⊕ 867/4 Z TORX® B0	1x TX 10x89; 1x TX 15x89; 1x TX 20x89; 1x TX 25x89; 1x TX 30x89	● 800/4 Z	1x 1.0x5.5x89	○ 840/4 Z	1x 3.0x89; 1x 4.0x89; 1x 5.0x89; 1x 6.0x89		Hook and Loop Fastener Strip 70		1x 50.0x70.0						
● 816 R	1x 1/4"x119																						
⊕ 851/4 Z	1x PH 1x89; 1x PH 2x89; 1x PH 3x89																						
⊕ 855/4 Z	1x PZ 1x89; 1x PZ 2x89; 1x PZ 3x89																						
⊕ 867/4 Z TORX® B0	1x TX 10x89; 1x TX 15x89; 1x TX 20x89; 1x TX 25x89; 1x TX 30x89																						
● 800/4 Z	1x 1.0x5.5x89																						
○ 840/4 Z	1x 3.0x89; 1x 4.0x89; 1x 5.0x89; 1x 6.0x89																						
	Hook and Loop Fastener Strip 70																						
	1x 50.0x70.0																						
	1x 393 S Bitholding screwdriver extra slim with flexible shaft																						
	<table border="1"> <tr> <td>●</td> <td>1x 1/4"x173,5</td> </tr> </table>	●	1x 1/4"x173,5																				
●	1x 1/4"x173,5																						
	1x 9850																						
	1x 172,0x30,0x392,0																						

Attention: The foam inserts do not fit in the previous model 05501051001 of the roller cabinet.

9780 Foam insert KNIPEX pliers set 1



3-piece pliers set (1x KNIPEX combination pliers, chrome-plated, 1x KNIPEX Cobra® high-tech water pump pliers, chrome-plated, 1x KNIPEX high leverage diagonal cutter, chrome-plated), in a two-coloured foam insert for the Tool Rebel roller cabinet. Width x height x depth: without tools 172 x 30 x 392 mm, with tools 172 x 38 x 392 mm.

05150180001		
	KNIPEX Combination Pliers 03 05 180	1x 180
	KNIPEX Cobra® High-Tech Water Pump Pliers 87 05 250	1x 250
	KNIPEX High Leverage Diagonal Cutter 74 05 160	1x 160
	9880	1x 172,0x30,0x392,0

9781 Foam insert KNIPEX pliers set 2

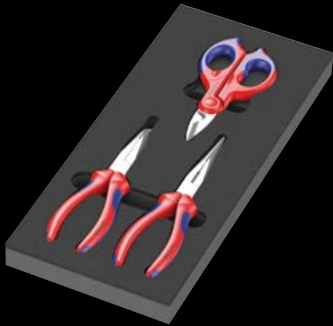

3-piece pliers set (1 KNIPEX snipe nose cutting pliers (stork beak pliers), 1 KNIPEX mechanics' pliers, 1 KNIPEX electricians' shears), in a two-coloured foam insert for the Tool Rebel roller cabinet. Width x height x depth: without tools 172 x 30 x 392 mm, with tools 172 x 38 x 392 mm.

05150181001		
	KNIPEX Snipe Nose Cutting Pliers (Stork Beak Pliers) 26 15 200	1x 200
	KNIPEX Mechanics' Pliers 38 25 200	1x 200
	KNIPEX Electricians' Shears 95 05 155	1x 155
	9881	1x 172,0x30,0x392,0

9782 Foam insert hammer set 1



6-piece tool set (1 PICARD® riveting hammer (500 gr), 4 colour-coded RENN-STEIG parallel pin punches, 1 RENNSTEIG flat cold chisel), in a two-coloured foam insert for the Tool Rebel roller cabinet. Width x height x depth: without tools 172 x 30 x 392 mm, with tools 172 x 35 x 392 mm.

05150182001		
	PICARD® riveting hammer 500 g, 0000101-500	1x 500,0
○	RENNSTEIG parallel pin punches Exclusive	1x 452 003 6 RC, 3,0x150; 1x 452 004 6 RC, 4,0x150; 1x 452 006 6 RC, 6,0x150; 1x 452 008 6 RC, 8,0x150
●	RENNSTEIG flat cold chisel 310 250 1	1x 25,0x13,0x23,0
	9882	1x 172,0x30,0x392,0

9783 Foam insert PFERD file set 1

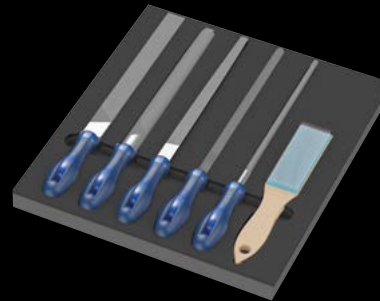

6-piece file set (1 PFERD file square PF1142 250 H2, 1 PFERD file half-round pointed PF 1152SP 250 H2, 1 PFERD file round PF1162 250 H2, 1 PFERD file hand PF1112 250 H2, 1 PFERD file three square PF 1132 250 H2, 1 PFERD scratch brush HBF ST 0.15), in a two-coloured foam insert for the Tool Rebel roller cabinet. Width x height x depth: without tools 344 x 30 x 392 mm, with tools 344 x 42 x 392 mm.

05150183001		
	PFERD machinist's file square PF1142 250 H2	1x 250
	PFERD machinist's file half-round pointed 1152SP 250 H2	1x 250
	PFERD machinist's file round 1162 250 H2	1x 250
	PFERD machinist's file hand 1112 250 H2	1x 250
	PFERD machinist's file three square 1132 250 H2	1x 250
	PFERD scratch brush HBF steel wire Ø 0.15	1x 232
	9883	1x 344,0x30,0x392,0